

## INSTALLATION

### GUIDE:

## AWE MK3 TTRS TRACK OR SWITCHPATH EXHAUST

THIS PRODUCT IS INTENDED FOR THE FOLLOWING VEHICLES\*:

YEAR	MAKE	MODEL	SUBMODEL	ENGINE
2017-2019	Audi	TT RS	Coupe	2.5l Turbo

THIS GUIDE IS INTENDED FOR THE FOLLOWING PART NUMBERS:

- 3025-33032 AWE SwitchPath™ Exhaust for Audi 8S TT RS - Diamond Black RS-style Tips
- 3020-33062 AWE Track Edition Exhaust for Audi 8S TT RS - Diamond Black RS-style Tips
- 3825-11026 AWE SwitchPath™ Conversion Kit for Audi 8S TT RS
- 3820-11032 AWE Track Edition Conversion Kit for Audi 8S TT RS

Welcome to the AWE family, and congratulations on your purchase of the **AWE Track Edition or Switchpath Edition Exhaust** system for the MK3 TTRS.

# PARTS LIST



**INSPECT ALL PARTS PRIOR TO DISASSEMBLY OF VEHICLE; IF DAMAGED OR MISSING, PLEASE CONTACT THE PLACE OF PURCHASE IMMEDIATELY.**

QTY	Description	Part Number
1	Rear merge inlet tube	A61
1	Mid merge	B97
1	Driver side tip outlet	C01
1	Passenger side tip outlet	C02
1	Rear branch section	C03
2	2.5" Accu-Seal clamp	TAS250
4	3.0" Accu-Seal clamp	TAS300
1	Driver side RS oval tip	61000453
1	Passenger side RS oval tip	61000454
<b>Integrated tip hardware kit (3910-41010)</b>		
4	1/4-20 x 3/4" carriage bolt	1010-1003-4
4	1/4-20 flanged locknut	90949A016
<b>Switchpath System Only</b>		
1	Driver side SwitchPath™ muffler section	B98
1	Passenger side SwitchPath™ valve section	B99
1	SBS valve motor simulator	150004
1	Valve simulator dowel pin	98380A457
4	7.5" cable tie	7130K59
<b>Track System Only</b>		
1	Driver side track rear leg	C04
1	Passenger side track rear leg	C05
2	SBS valve motor simulator	150004
2	Valve simulator dowel pin	98380A457
8	7.5" cable tie	7130K59

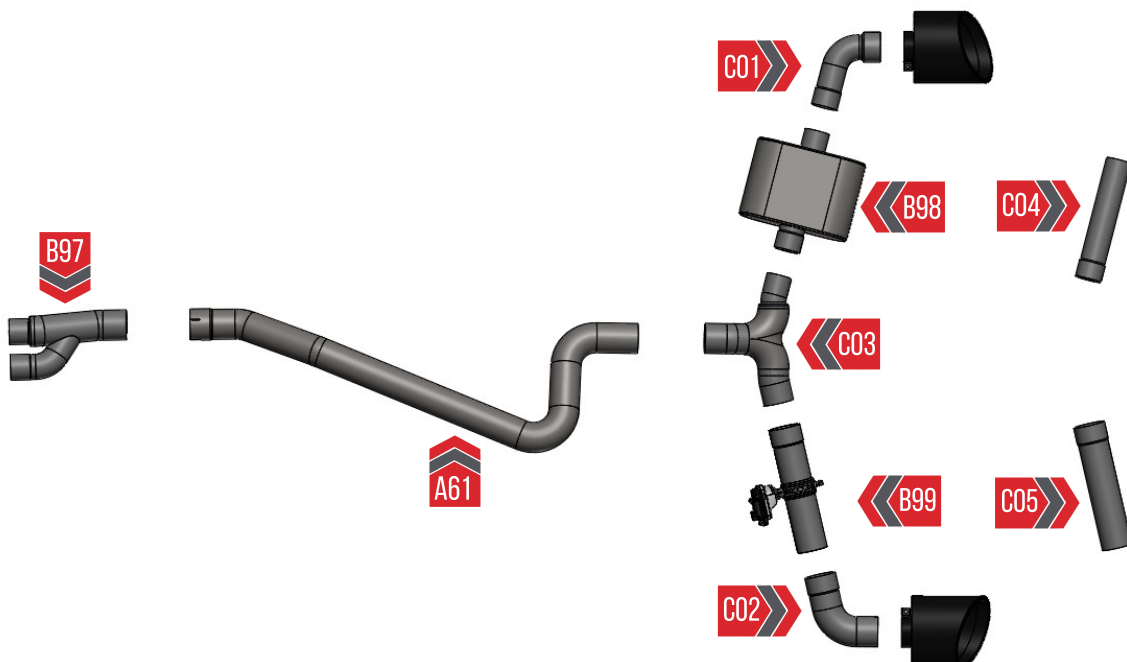

## STEP 1

Installation of the AWE exhaust system is the reverse of the removal OEM exhaust.



Always refer to the manufacturer service manual for precise torque specifications on all OEM fasteners.



**CAUTION:** The exhaust may be **VERY HOT** — allow adequate time for the system to cool down before disassembly. Severe burns and injury will occur if skin comes into contact with a hot exhaust system.

Start by removing the rear OEM chassis brace shown in **Figure 1** and place it out of the way. These will be reinstalled after the AWE Exhaust is in place.

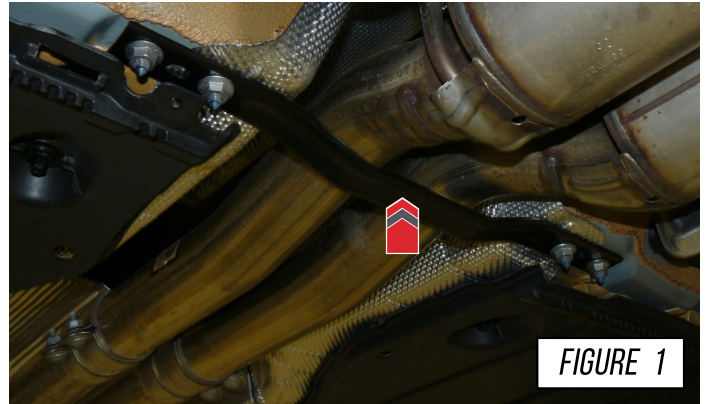

## STEP 2

Loosen the OEM sleeve clamps shown in **Figure 4**. These will also be reused during installation.



## STEP 3

Locate and remove the hangers from the hanger bushings, locations shown by the arrows in **Figure 3**.



**NOTE:** Use a penetrant oil to spray onto the hangers where they are hung in the rubber bushing, this will help with removal.

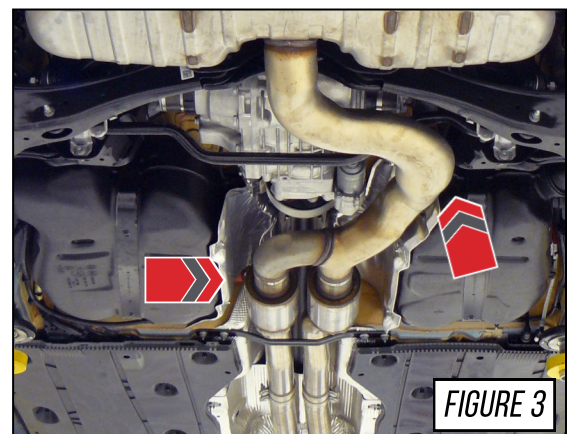

## STEP 4

With the entire system supported, loosen and remove the bolts that secure the hangers on either side of the muffler.

The arrow in **Figure 4-1** shows the location of the passenger side hanger bolt.

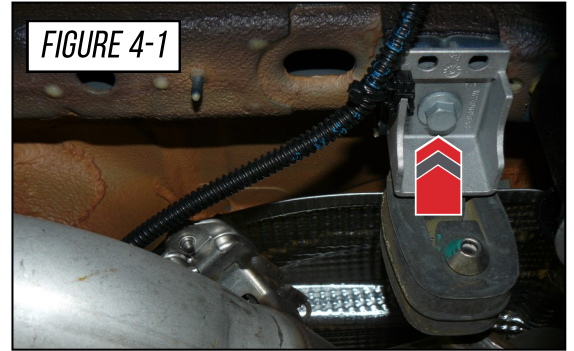

The arrow in **Figure 4-2** shows the location of the driver side hanger bolt.

Slide the sleeve clamps, loosened in *Step 2*, rearward towards back end of the car.

Remove the OE exhaust from the vehicle.

 **WARNING:** The OE exhaust is best handled by two (2) people.

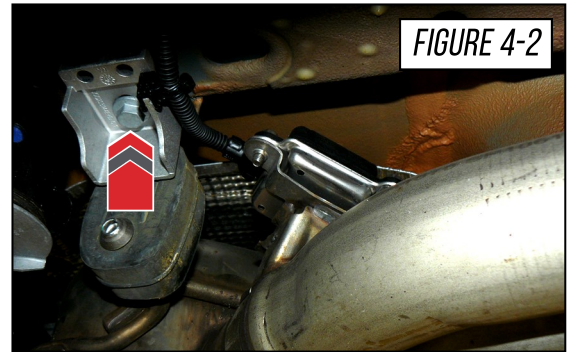

## STEP 5

Reuse the OEM sleeve clamps to install the mid-pipe merge section (part B97), as seen in **Figure 5**

Do not fully torque any clamps until the final step, after the entire system has been installed and adjusted to satisfaction.





## STEP 6

Use one of the included 3.0" Accu-Seal clamps to slip over the inlet side on the axle Tube (part A61), install onto the outlet of the merge section, as shown by **Arrow A** in **Figure 6**

Reinstall the hanger brackets back into their factory locations and insert the hangers on the axle tube

At this point the chassis brace can be reinstalled using the factory hardware, as shown by **Arrow B** in **Figure 6**

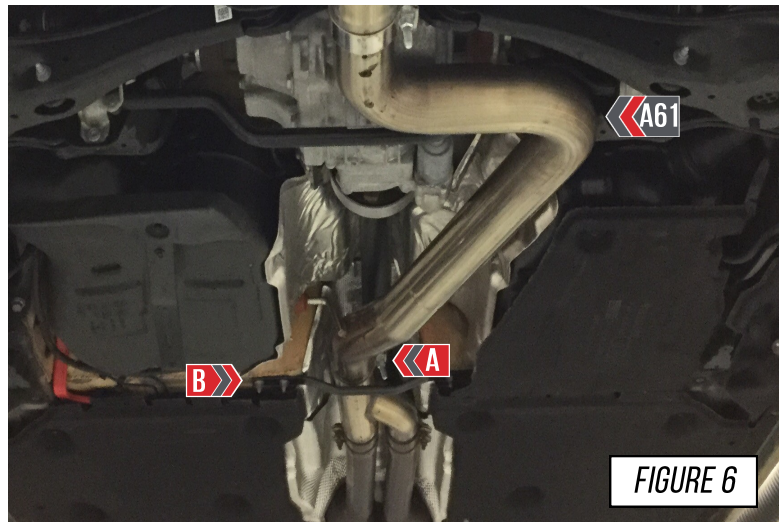

FIGURE 6

## STEP 7

Use one of the included 3.0" Accu-Seal clamps to install the rear branch tube (part C03) as seen in **Figure 7**

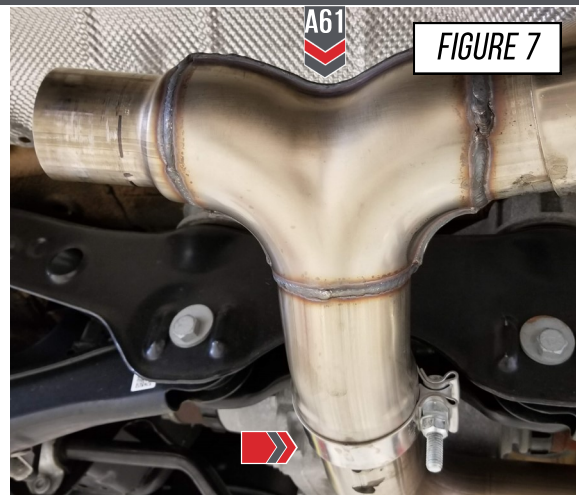

FIGURE 7

## STEP 8

Continue by installing the drivers side rear leg section (part B98 for Switchpath and C04 for track) with the supplied 2.5" Accu-Seal clamps.

Next, install the drivers side tip outlet (part C01) onto the drivers side rear leg.

Make sure to slide the clamps over the tubes before installing onto the vehicle

Install the hangers on the rear leg into the factory hanger location as seen in **Figure 8**

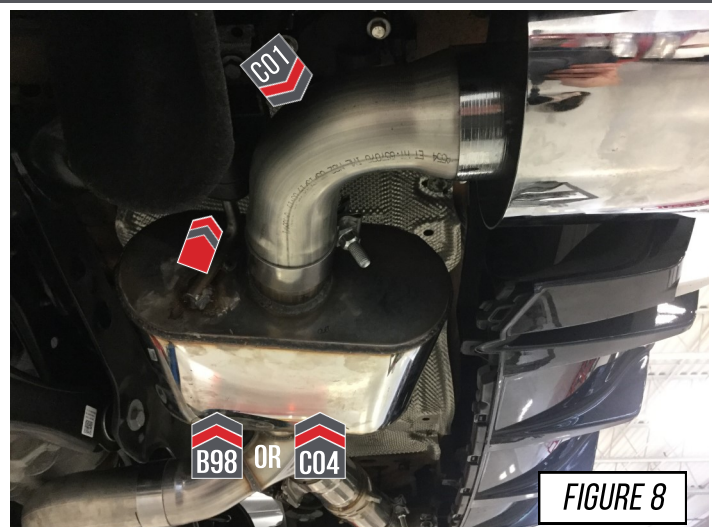

FIGURE 8

## STEP 9

### **For SwitchPath™ Installation:**

Transfer the factory valve motor to the bracket located on the drivers side tailpipe section, and reconnect the factory harness.

Using the factory hardware, install the driver side motor onto the included MVS bracket and pin, as shown in **Figure 9-1**.

Install the MVS Bracket onto the factory valve motor, from the driver side tailpipe section of the OE exhaust, using the factory mounting bolts, as shown by **Arrow A** in **Figure 9-2**.

Use a cable-tie to secure the motor up and away from the exhaust and reconnect the factory harness, as shown by **Arrow B** in **Figure 9-2**.

Start the vehicle, and switch to Dynamic mode; confirm this opens the valve to verify proper operation.



**PRO-TIP:** A properly indexed OE valve motors is critical to a smooth installation. If the valve motors have been operating while disconnected from the factory valve body, re-indexing will be required.

### **For Track Edition Installation:**

Remove the factory valve motors from the tailpipe section of the OE exhaust.

Install the MVS Bracket onto the factory valve motor, from the driver side tailpipe section of the OE exhaust, as shown by **Arrow A** in **Figure 9-2**.

Use a cable-tie to secure the motor up and away from the exhaust and reconnect the factory harness, as shown by **Arrow B** in **Figure 9-2**.

Reconnect the factory harnesses to the valve control motors and repeat MVS Bracket installation for the passenger side.

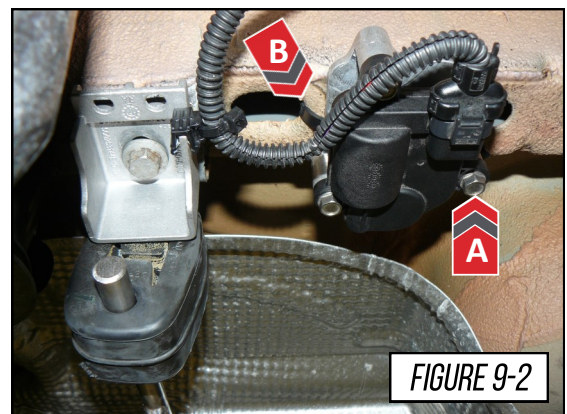
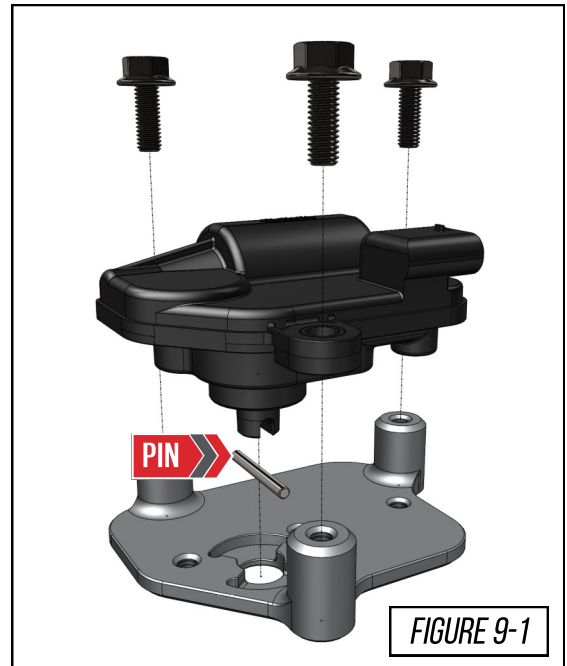

## STEP 10

Continue with installing the passengers side rear leg section (part B94 for Switchpath and C05 for track) with the supplied 2.5" Accu-Seal clamps.

Install the drivers side tip outlet (part C02) onto the drivers side rear leg.

Make sure to slide the clamps over the tubes before installing onto the car

Make sure to install the hangers on the rear leg into the factory hanger location, as seen in **Figure 10**

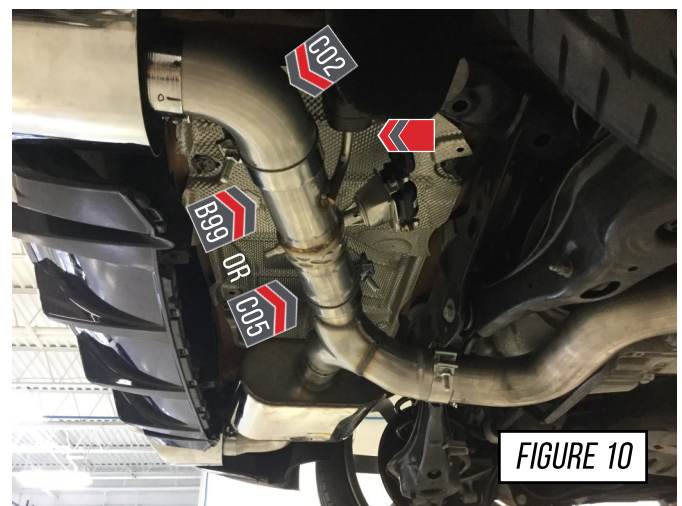



## STEP 11

Use the included hardware to install the driver and passenger side RS tips as shown in **Figure 11**



## STEP 12

It is crucial to install each section and Accu-Seal clamp correctly to prevent loose joints and exhaust leaks between the tubing connections.

**Arrow A** in **Figure 12** shows the expanded pipe and the preinstalled Accu-Seal clamp being brought up to the corresponding pipe.

**Arrow B** in **Figure 12** shows the overlapping pipe installed correctly over the corresponding pipe.

**Arrow C** in **Figure 12** shows the Accu-Seal clamp being brought to the edge of the expanded pipe.

### NOTES:



- Do not torque any Accu-Seal clamp until the entire exhaust has been installed and adjusted.
- Torque specification is a minimum of 40 ft/lbs.

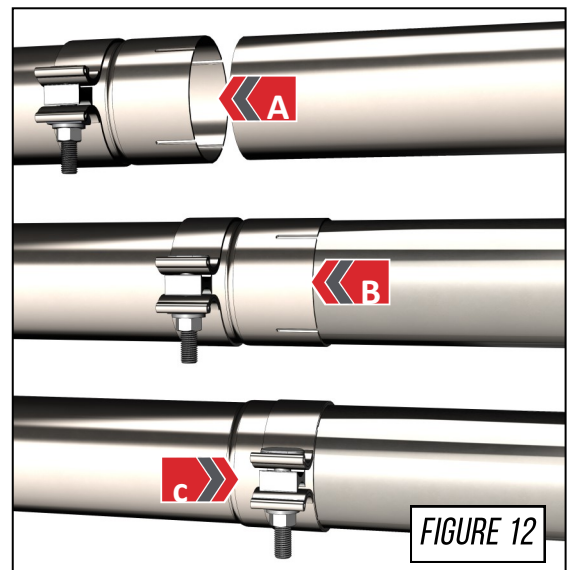

## STEP 13

After the system has been properly installed in the factory exhaust hangers, and adjusted; begin torquing the clamps to lock everything into location.

Begin torquing from the forward most clamps and move gradually towards the rear of the vehicle.



**PRO-TIP:** Periodically check the tip alignment to ensure proper placement after torquing *each* Accu-Seal clamp.

**Installation is complete!**



# ENJOY!



## TROUBLESHOOTING

Issue	Solution
Exhaust is not fitting correctly	Most fitment issues are due to improperly adjusted exhaust. This includes tip fitments and rattling due to chassis contact. Check out our <a href="#">fitment guide</a> for more installation tips.
Wrong or missing parts	Double check the parts list for your system and compare them with what you received. Fill out our contact form, found below and let us know what parts you need.
Valves are not operating correctly	Take a look at our <a href="#">Electronic Valve Troubleshooting Guide</a>

## CARE

Once installed properly, your AWE exhaust will provide years of trouble-free performance.

The exhaust volume and sound will settle with usage; 800-1000 miles is required to break-in new exhaust systems.

Periodic cleaning of exhaust tips is necessary to maintain proper finish, especially in areas prone to road salt and caustic deicing solutions. Use a mild soap and water solution or car wax to clean the finish. Avoid using abrasive polishes, as they can scratch the finish.

Any questions or comments,  
please do not hesitate to contact us:

**AWE**  
199 Precision Drive  
Horsham, PA 19044  
215-658-1670  
[CONTACT FORM](#)

## WARRANTY

Up-to-date warranty information is found [HERE](#).