



Detroit Speed

Front Speed Kit 1 & 2

1964-70 Ford Mustang & 1960-65 Ford Falcon/Mercury Comet

P/N: 031374DS, 031374-SDS, 031375DS, 031375-SDS,

031377DS, 031377-SDS, 031378DS, 031378-SDS,

031380DS, 031380-SDS, 031381DS & 031381-SDS

The Detroit Speed Front Speed Kits update the look, handling, and performance of your classic Mustang, Falcon, or Comet to modern standards. Designed as a "bolt in" system, the speed kits require minimal modifications to your factory vehicle. This kit lowers the ride height 1-1/2" to 3" using "Detroit Tuned" coilover shocks specifically designed for the suspension system.



PN: 031378DS Speed Kit 2 Shown

Item	Part Description	Quantity
1	Upper Control Arm, LH & RH	2
2	Lower Control Arm, LH & RH	2
3	Upper Shock Mount, LH & RH	2
4	Shock Tower Closeout, LH & RH	2
5	Shock Mount Closeout	2
6	Shock Mount Spacer	2
7	Spindle, LH & RH (Speed Kit 2 Only)	2
8	Outer Tie Rod End (Speed Kit 2 Only)	2
9	1-1/4" OD Sway Bar Kit (Speed Kit 2 Only)	1
10	Camber Shim Kit (Speed Kit 2 Only)	1
11	Coilover Shocks	2
12	Coilover Springs	2
13	Instructions	1



Hardware Kit Checklist - Detroit Speed Front Speed Kit			
Part Number	Description	Quantity	Check
200145DS	Upper Shock Mount Hardware	1	
980002FS	1/2"-20 x 2-3/4" L Hex Head Bolt	2	
980116FS	3/8"-16 x 7/8" L Flanged Head Bolt	6	
980139FS	5/16"-24 x 2-1/4" L Hex Head Bolt	6	
960004FS	1/2"-20 Nylock Nut	2	
960049FS	5/16"-24 Nylock Nut	6	
970043FS	5/16" SAE Washer	6	
99030022	1/2" ID x 1" L Steel Bushing	2	
200146DS	Jounce Bumper Kit	1	
030504DS	Jounce Bumper	2	
99030336	Jounce Bumper Spacer	2	
960033FS	5/16"-18 Nylock Nut	2	
970027FS	5/16" SAE Washer	2	

1964-66 Mustang/1960-65 Falcon & Comet Only			
200137DS	Upper Control Arm Hardware	1	
980058FS	1/2"-20 x 3" L Hex Head Bolt	4	
960004FS	1/2"-20 Nylock Nut	4	
970037FS	1/2" SAE Washer	4	
920009FS	1-1/8" x 1/8" Body Shim	20	
99030642	Upper Control Arm Drill Guide	1	
99030643	Upper Control Arm Washer	4	
200139DS Lower Control Arm Hardware			
980026FS	1/2"-20 x 2-1/2" L Hex Head Bolt	2	
960004FS	1/2"-20 Nylock Nut	2	
960116FS	M20-1.5 Locknut	1	
99030321	1/2" ID x 5/8" L Steel Bushing	2	
99030617	Strut Rod Washer	2	
99030634	Strut Rod Crows Foot Wrench	1	
1967-70 Mustang Only			
200141DS	Upper Control Arm Hardware	1	
980059FS	3/8"-24 x 1" L Hex Head Bolt	4	
960004FS	1/2"-20 Nylock Nut	4	
970037FS	1/2" SAE Washer	4	
920009FS	1-1/8" x 1/8" Body Shim	20	
99030650	Upper Control Arm Drill Guide	1	
99030651	Upper Control Arm Washer	4	
200143DS Lower Control Arm Hardware			
980026FS	1/2"-20 x 2-1/2" L Hex Head Bolt	2	
960004FS	1/2"-20 Nylock Nut	2	
960116FS	M20-1.5 Locknut	1	
99030321	1/2" ID x 5/8" L Steel Bushing	2	
99030618	Strut Rod Washer	2	
99030634	Strut Rod Crows Foot Wrench	1	

Fastener Torque Specifications			
Application	Thread Size	Torque (ft.-lbs.)	Threads
Upper Shock Chassis Mount	5/16"-24	20	Anti-Seize
Upper & Lower Shock Mount	1/2"-20	60	Anti-Seize
Shock Tower Closeout	5/16"-18	13	Anti-Seize
Upper Control Arm	1/2"-20	80	Anti-Seize
Lower Control Arm Rear Mount	1/2"-20	80	Anti-Seize
Lower Control Arm Strut Rod Mount	M20-1.5	200	Anti-Seize
Upper Control Arm Ball Joint Stud*	1/2"-20	60-75	None
Lower Control Arm Ball Joint Stud*	9/16"18	70-90	None
Outer Tie Rod End Stud Nut*	7/16"-20	45-55	None
Sway Bar Mount	3/8"-20	35	Anti-Seize
Sway Bar End Link	M12-1.75	60	Red Loctite
* Always tighten slotted nuts to line up with the cotter pin hole			

Specifications – Detroit Speed Front Speed Kit	
Total Suspension Travel	5.5"
Ride Height*	16.6" ± 0.5"
Static Camber	-0.5° ± 0.2°
Static Caster	+7.0° ± 0.5°
Static Toe	0.0° ± 0.1°
*Measured from the center to center of the coilover shocks	

Installation Instructions

1. Raise the vehicle and support with jack stands under the frame or use a vehicle hoist. Remove the front wheels.
2. Disassemble the brake calipers from the stock spindles. If you have purchased Speed Kit 1, you will reuse your factory spindles.
3. Remove the front suspension from the vehicle along with the tubular crossmember. This will need to be removed in order to remove the lower control arms (Figure 1). Save the hardware used from the jounce bumper bracket as it will be used later.



Figure 1 – Remove Suspension

Drill Upper Control Arm Mounts

4. Locate the provided drill guide in the upper control arm kit (Figure 2). **NOTE:** If your vehicle has already been modified with the popular “Shelby Drop”, use those mounting holes to install the upper control arms. Skip to Step 10.



Figure 2– Drill Guide

5. Place the drill guide up against the strut tower and line up the large holes in the drill guide with the factory upper control arm holes. **NOTE:** The drill guide is labeled for which direction needs to point towards the front of the vehicle.
6. Place two of the provided 1/2" bolts through the drill guide and the factory holes in the strut tower. Tighten the bolts to hold the drill guide in place (Figure 3).

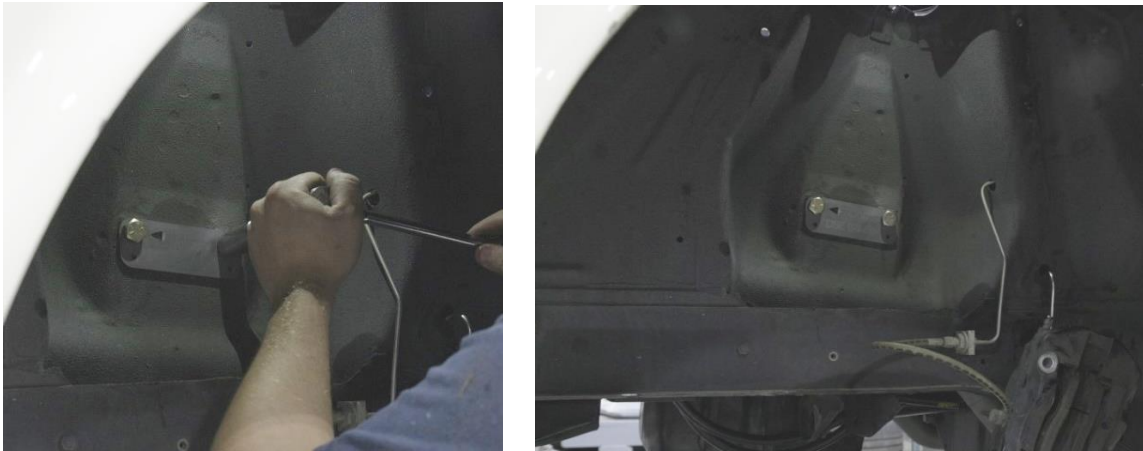

Figure 3 – Install Drill Guide

7. Use the drill guide to drill two 3/16" pilot holes in the strut tower. (Figure 4). Remove the drill guide from the strut tower.



Figure 4 – Mark Drill Locations

8. Drill the two pilot holes to a final drill size of 33/64" (Figure 5). **NOTE:** It is recommended that additional pilot holes be drilled first before drilling the final 33/64" holes.



Figure 5 – Drill Mounting Holes

9. Repeat Steps 5 through 8 for the opposite side of the vehicle by flipping the drill guide over (Figure 6).



Figure 6 – Flip Drill Guide Over

Install Upper Shock Mounts

NOTE: Installation differs depending on the model year.

For 1967-70 Mustang Only:

10. Remove the hardware holding the factory strut tower brace to the strut towers. With the factory strut tower brace in place, transfer punch the hole locations onto the strut tower.
11. Drill the three locations to a final drill size of 3/8". **NOTE:** It is recommended that pilot holes be drilled first before drilling the 3/8" holes (Figure 7).



Figure 7 – Drill Strut Tower (Strut Tower Brace Not Pictured)

For 1964-70 Mustang Only:

12. Loosen the strut tower brace at the strut towers (Figure 8 on the next page). Place the provided strut tower closeout plates between the strut tower brace and the strut tower. **NOTE:** The DSE logo engraved on the closeout plates will be facing up, inside the center hole of the strut tower brace.

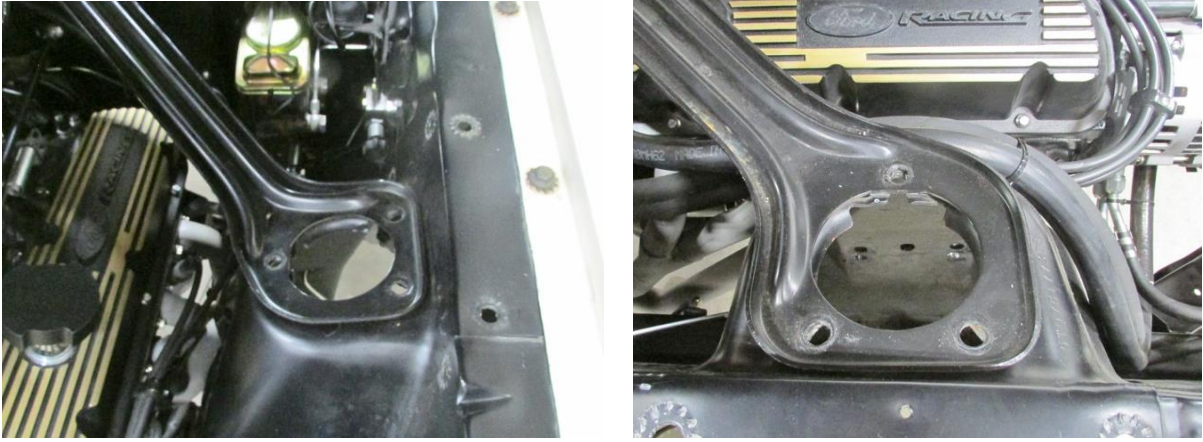

Figure 8 - Loosen Strut Tower Brace

13. Place the provided 5/16"-24 x 2-1/4" L hex head bolts and 5/16" SAE washers down through the holes in the strut tower brace, closeout plate and strut tower on both sides of the vehicle (Figure 9).

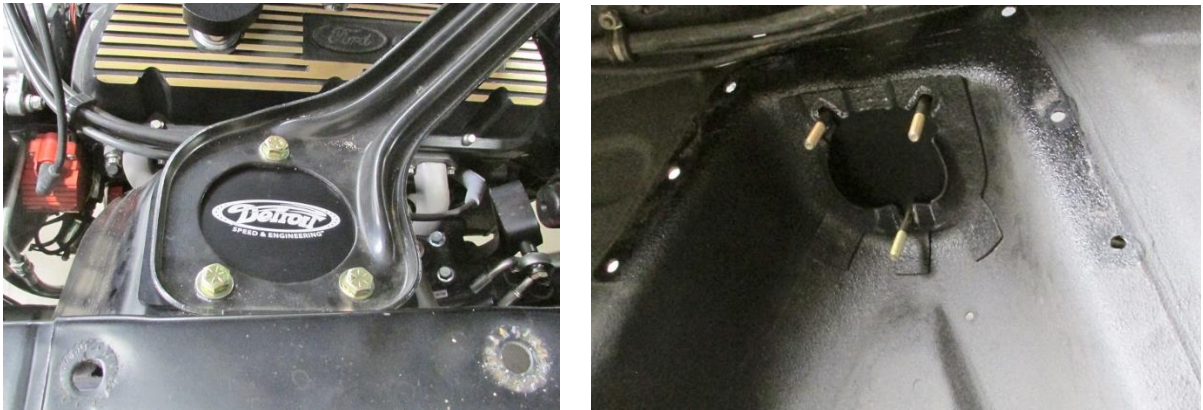

Figure 9 - Locate Strut Tower Brace Hardware

For 1960-65 Falcon/Comet Only:

14. Place the provided strut tower closeout plates on top of the strut tower. **NOTE:** The DSE logo engraved on the closeout plates will be facing up, inside the center hole of the strut tower brace.

15. Place the provided 5/16"-24 x 2-1/4" L hex head bolts and 5/16" SAE washers down through the holes in the strut tower closeout plates on both sides of the vehicle.

All Applications:

16. From underneath the strut tower, place one of the shock mount spacers against the strut tower using the 5/16" bolts to center the spacer.

17. Place the upper shock mount up against the spacer with the 5/16" bolts passing through the holes in the upper shock mount plate. **NOTE:** Make sure you have the correct upper shock mount for each side of the vehicle. They will be stamped "L" for the driver side and "R" for the passenger side. The welded-in bushing on the shock tabs will be towards the rear of the vehicle.

18. Install the provided 5/16" Nylock nuts and 5/16" AN washers on the threads of the bolts and tighten (Figure 10 on the next page). **NOTE:** Use anti-seize on the threads of the bolts. Torque the 5/16"-24 hardware to 25 ft-lbs. Repeat Steps 16 through 18 for the opposite side of the vehicle.

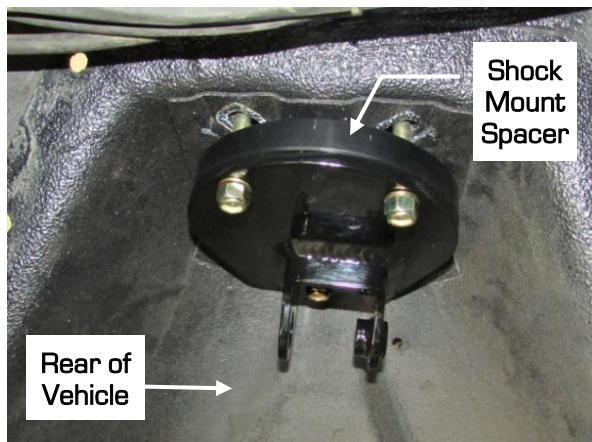

Figure 10 - Install Upper Shock Mounts

Install Upper Control Arms

19. Place the provided four upper control arm slug washers into the factory upper control arm holes from the engine side of the strut tower. The open holes in the washers will line up with the drilled holes from the previous step (Figure 11). **NOTE:** For 1964-66 Mustangs, it may require slight grinding to the chassis to allow the washer to sit flat (Figure 12).



Figure 11 - Install Control Arm Slug Washers

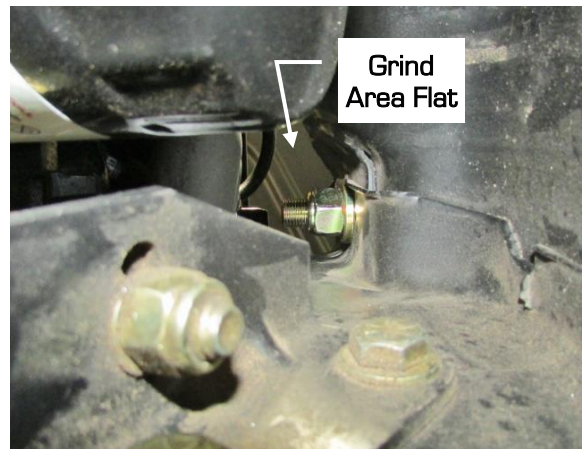

Figure 12 - Grind Area Flat

20. Identify the left and right hand upper control arms. The DSE decal will point towards the front of the vehicle. Position the upper control arms to the strut tower and place the provided 1/2"-20 x 3" L hex head bolts and washers through the upper control arms, strut tower and slug washers (Figure 13).

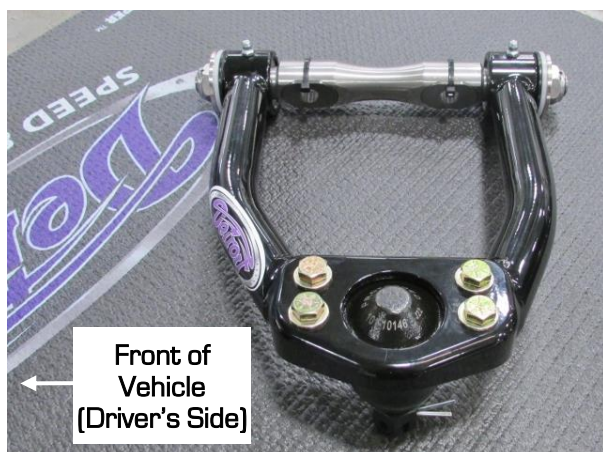

Figure 13 - Install Upper Control Arms

21. Install the provided 1/2"-20 Nylock nuts onto the threads of the upper control arm bolts. Leave the hardware loose for now (Figure 14). **NOTE:** Use anti-seize on the threads of the bolts.



Figure 14 - Install Hardware

22. Install the nominal amount of 1/8" thick body shims in between the strut tower and the upper control arm cross shafts on both bolts (Figure 15). Final shim amount may vary from nominal. **NOTE:** The photo below shows the DSE camber shim kit (PN: 031726DS). Tighten the 1/2"-20 hardware and torque to 75 ft-lbs.

Nominal Camber Shim	
1964-1966 Mustang, 1960-65 Falcon/Comet	1/2" Total (4 Shims)
1967-1970 Mustang	1/4" Total (2 Shims)



Figure 15 - Install Camber Shims

Install Lower Control Arms

23. Identify the left and right hand lower control arms. The strut rod will point towards the front of the vehicle (Figure 16).



Figure 16 - Lower Control Arms

24. Remove the cable tie, install the provided bushing spacers on both sides of the rear bushing before it's installed into the rear mount (Figure 17).



Figure 17 - Install Bushing Spacers

25. Place the lower control arm in the factory mounting locations so the strut rod will go through the front mount and the bushing will slide in between the rear mount (Fig. 18).



Figure 18 - Install Lower Control Arm

26. **1964-66 Mustang, 1960-65 Falcon/Comet:**

Re-install the factory hardware. Insert the bolt from the rear of the vehicle to provide clearance for the factory bolt in the crossmember (Figure 19). Do not torque at this time. **NOTE:** If you have purchased the lower eccentric kit (PN: 031728DS) for your 1964-66 Mustang, refer to those instructions for installation.



Figure 19 - Install Hardware

1967-70 Mustang:

Re-install the factory hardware with eccentric washers. Do not torque at this time. **NOTE:** If you have purchased DSE Speed Kit 2 for your 1967-70 Mustang, Lower Eccentric Kit (PN: 031729DS) is included. Refer to those instructions for installation.

27. Place the provided strut rod washer onto the threads of the strut rod followed by the M20-1.5 Nylock nut and tighten (Figure 20). Use anti-seize on the threads of the bolt. Use the provided crows foot wrench to hold the strut rod while tightening the M20-1.5 Nylock nut. Do not torque at this time.

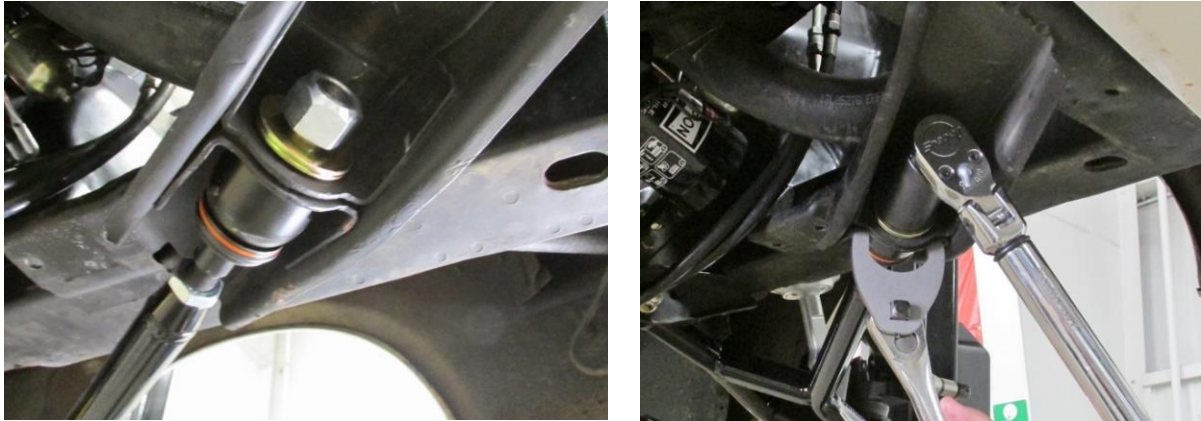

Figure 20 – Install Strut Rod Hardware

28. Repeat Steps 25 through 27 for the opposite side of the vehicle. Torque the M20-1.5 Nylock nuts to 150 ft-lbs. and the 1/2"-20 Nylock nuts to 75 ft-lbs.

Install Spindles

DSE Speed Kit 1: Re-use Existing Spindles.

DSE Speed Kit 2: Install the 1964-70 Big Bearing Spindle included with the kit. The customer is to source the brake kit separately.

29. Clean any grease from the upper and lower ball joint studs and the spindle holes with a clean rag and lacquer thinner.

30. Place the spindle on the lower ball joint stud. **NOTE:** Turn and position the ball joint stud so the cotter pin locates from front to rear to ease installation. Install the provided spacer onto the ball joint stud followed by the lower ball joint castle nut and tighten (Figure 21). Do not torque yet.

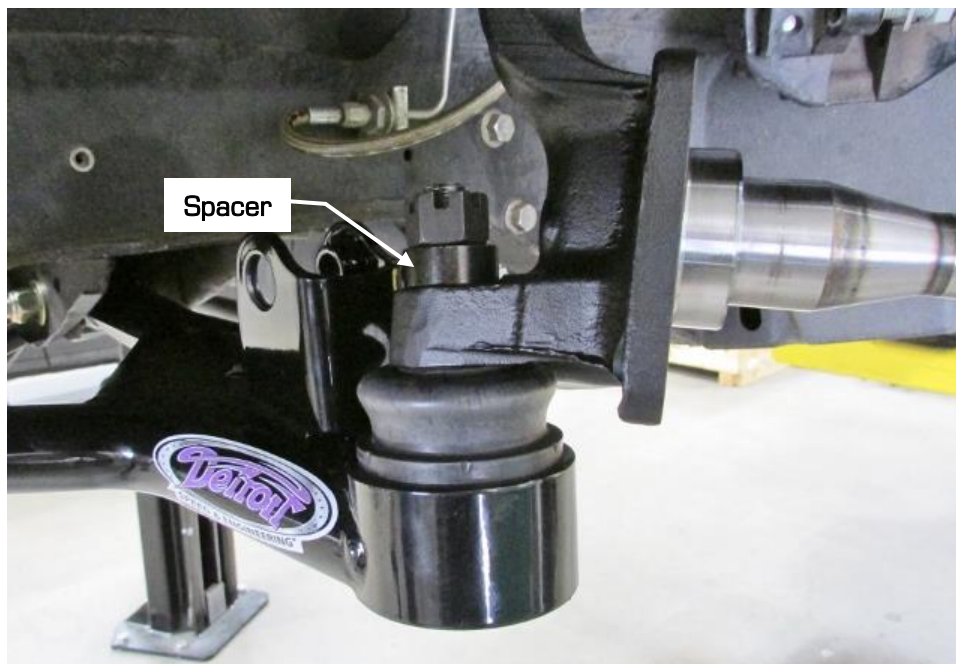

Figure 21 – Install Spacer & Castle Nut

31. Lower the upper control arm to install the spindle to the upper control arm ball joint (Figure 22). **NOTE:** Turn and position the ball joint stud so the cotter pin locates from front to rear to ease installation. Install the provided upper ball joint castle nut onto the upper ball joint stud and tighten.



Figure 22 - Install Upper Ball Joint

32. Torque the lower ball joint nut to 90 ft-lbs. and the upper ball joint to 60 ft-lbs. (Fig. 23).



Figure 23 - Torque Castle Nuts

33. Install the cotter pin in the upper and lower ball joint stud/castle nut (Figure 24). Repeat Steps 29 through 33 for the opposite side of the vehicle.

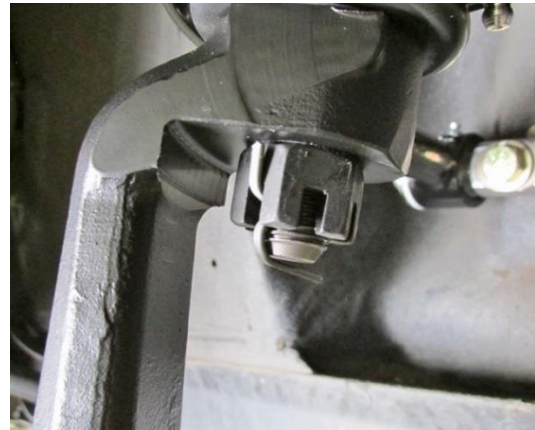

Figure 24 - Install Cotter Pins

34. **Speed Kit 2 Only:** Measure the thread engagement of the outer tie rod in the tie rod adjuster. Remove the existing outer tie rod from the tie rod adjuster. Install the provided outer tie rod end (PN: 104-10350) into the tie rod adjuster (Figure 25). Set the thread engagement to the measurement taken earlier for a starting position.



Figure 25 - New Outer Tie Rods

35. Insert the outer tie rod end into the steer arm. **NOTE:** Turn and position the ball joint stud so the cotter pin locates from front to rear to ease installation. Install and tighten the outer tie rod washer and castle nut (Figure 26). Torque to 45 ft-lbs.



Figure 26 - Install Outer Tie Rod

36. Install the cotter pin in the outer tie rod stud/castle nut (Figure 27). Repeat Steps 34 through 36 for the opposite side of the vehicle.



Figure 27 - Install Cotter Pins

Install Coilover Shocks & Springs

37. Before installing each coilover shock, it is necessary to build each assembly. Remove the lower spring seat from the retaining ring by moving it down off the lower shock mount (Figure 28).



Figure 28 – Removing Lower Spring Seat

38. Remove the retaining ring from the lower shock mount and pass the lower spring seat over the lower shock mount (Figure 29).



Figure 29– Lower Spring Seat & Retaining Ring

39. Thread the spanner nut all the way to the top of the coilover shock and install the provided Torrington bearing set (Figure 30) on each shock. Install one thrust washer, followed by the roller bearing and then another thrust washer. DSE recommends using high pressure grease between the roller bearing and thrust washers.

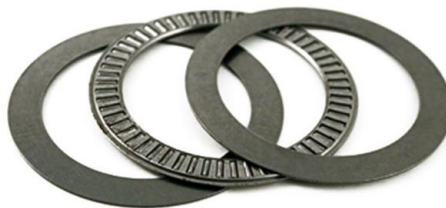

Figure 30 – Torrington Bearing Set

40. Slide the coilover spring over the lower shock mount. Install the lower spring seat back over the lower shock mount and re-install the retaining ring back on to the lower shock mount. Press the lower spring seat up onto the retaining ring so it locks in place. The coilover assembly is now complete and ready to be installed.

41. Make sure the upper mounting holes are clean and free of any paint, so the bolts and spacers slide into the mounting tabs. Locate the upper and lower shock mount bolts and spacers (Figure 31).



Figure 31 - Shock Mounting Bolts & Spacers

42. Slide the provided 1/2"-20 x 2-3/4" L hex head bolt and 1/2" x 1" L spacer through the upper coilover mount. Make sure that the bolt is facing rearward (The bolt head is toward the front).
43. Place the body side of the shock up to the upper shock mount. Install the bolt and spacer through the shock eyelet so it passes through the welded bushing on the upper shock mount. Use anti-seize on the threads of the bolt and install the provided 1/2"-20 Nylock nut and washer. Tighten the hardware, however, do not torque at this time (Figure 32).

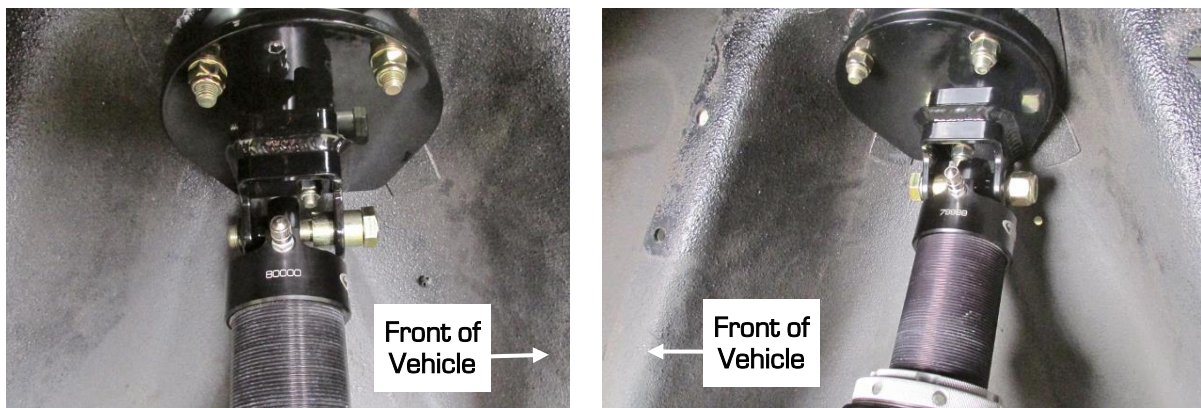

Figure 32 - Install Upper Shock Hardware

44. Raise the lower control arm up with a floor jack until the shaft side eyelet on the shock reaches the lower shock mount on the lower control arm. Make sure the mounting holes are clean and free of any paint, so the bolts and spacers slide into the mounting tabs.
45. Slide the provided 1/2"-20 x 2-1/2" L hex head bolts and 1/2" x 5/8" L spacer through the lower coilover mount and shock eyelet so it passes through the welded bushing on the lower shock mount (Figure 33 on the next page). Make sure that the bolt is facing rearward (The bolt head is toward the front).

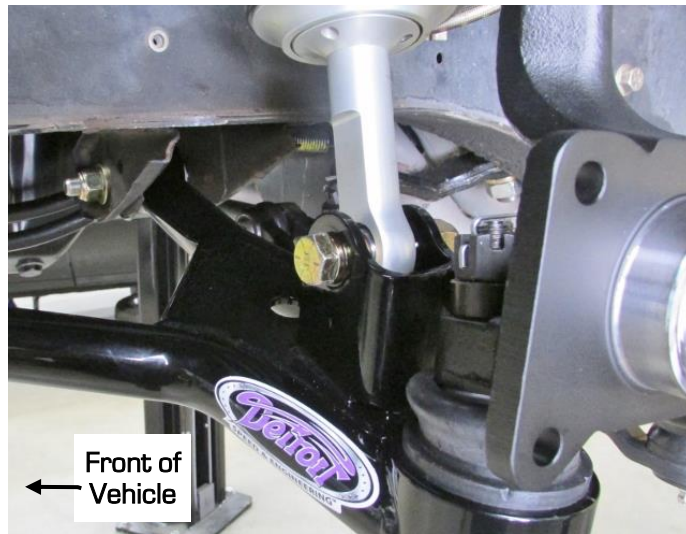

Figure 33 - Install Bolt & Spacer

46. Use anti-seize on the threads of the bolt and install the 1/2"-20 Nylock nut and tighten. **NOTE:** If you have single adjustable shocks, the adjustment window on the eyelet should be facing the rear of the vehicle. (Figure 34).

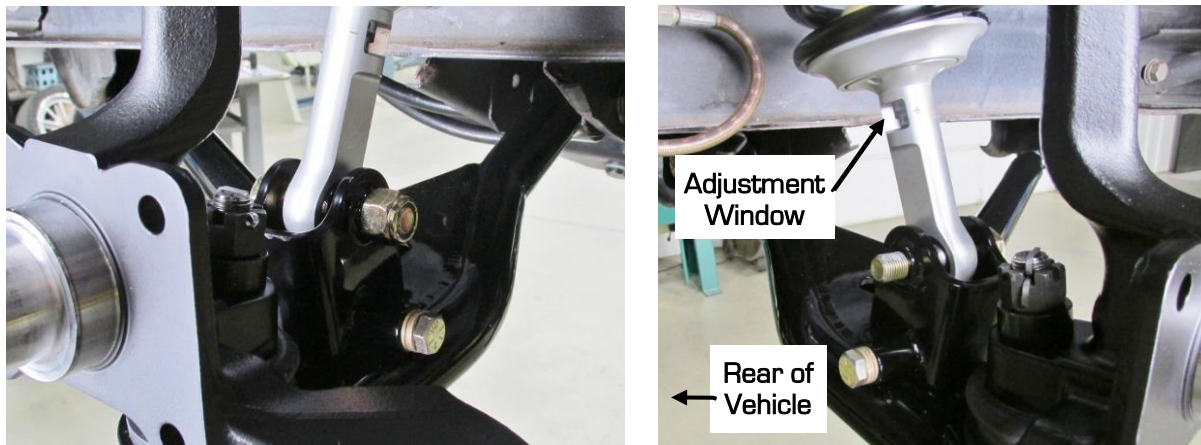

Figure 34 - Tighten Lower Shock Hardware

47. Repeat this process for the opposite side of the vehicle. Torque the 1/2"-20 hardware to 60 ft-lbs.

Install Shock Tower Closeout

48. Locate the left and right hand shock tower closeout (Figure 35). There will be an "L" stamped on the inside of the closeout for left-hand (driver's side) or an "R" stamped on the inside for right-hand (passenger's side).

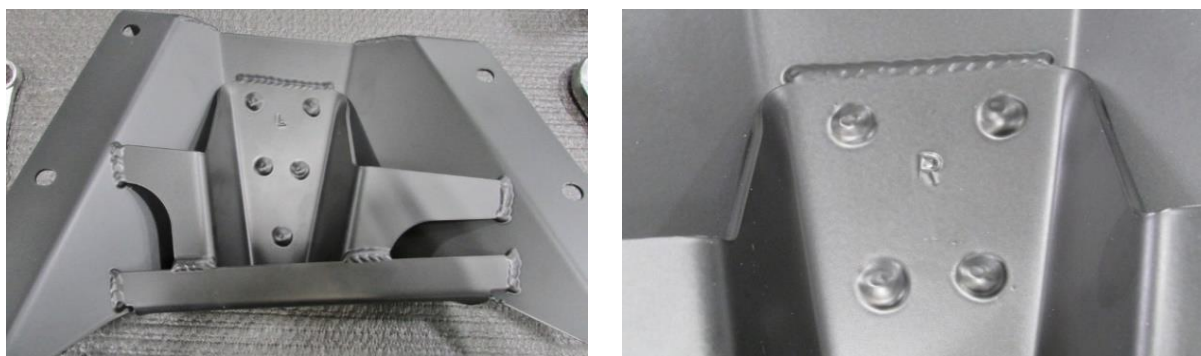

Figure 35 - Locate Shock Tower Closeouts

49. Place the provided aluminum jounce bumper spacers over the threads of the jounce bumpers. Install the jounce bumpers through the slotted hole in the shock tower closeouts (Figure 36).



Figure 36 – Install Jounce Bumper & Spacer

50. Place the provided 5/16" SAE washer over the threads of the jounce bumper followed by the 5/16"-18 Nylock nut (Figure 37). Leave the hardware loose for now so you can adjust the position of the jounce bumper later.



Figure 37 – Install Hardware

51. Place the correct side shock tower closeout to the vehicle so the holes in the closeout align with the holes on the strut tower. Use the same hardware that was removed from the OEM jounce bumper bracket to install the shock tower closeouts. Tighten the hardware (Figure 38).

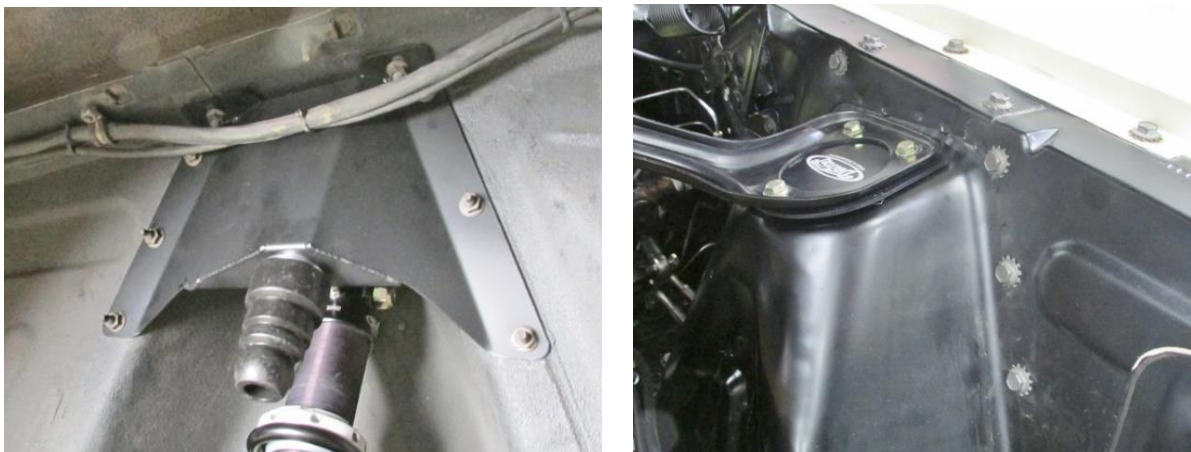

Figure 38 – Install Closeout

52. Next, align the jounce bumper position to the upper control arms. Raise the control arm assembly using a floor jack so the jounce bumper contacts the upper ball joint. Adjust the bumper position so it contacts the center of the upper ball joint as needed. Tighten the 5/16"-18 hardware (Figure 39).



Figure 39 – Align Jounce Bumper

53. Re-install the tubular crossmember back into the vehicle (Figure 40).

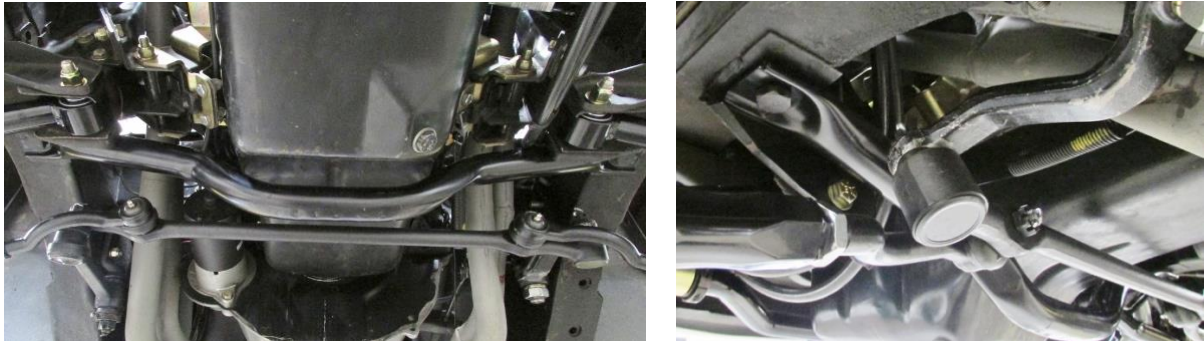

Figure 40 – Re-Install Tubular Crossmember

DSE Speed Kit 1: Install the factory or customer sourced sway bar.

DSE Speed Kit 2: Install included DSE sway bar.

54. Follow the instructions that came with PN: 031421DS or 031422DS. All required components and hardware are included with the DSE sway bar kits. **NOTE:** DSE recommends disconnecting the sway bar end links while setting the ride height.

55. Re-install the front brakes. Make sure the brake hoses are routed so they don't interfere with the suspension (Figure 41).



Figure 41 – Re-Install Brakes

56. Install the wheels and lower the vehicle to the ground. Torque the wheels to the manufacturer's specifications.

Setting the Vehicle Ride Height

57. Once the vehicle is set on the ground, settle the suspension by jouncing both the front and rear by hand by pressing down on the body and rolling the vehicle back and forth.

58. Check the ride height at this point and adjust as necessary. Before adjusting the ride height, DSE recommends cleaning the threads of the shock. Once the threads are clean, DSE recommends applying dry bicycle chain lube to the threads of the shock body before adjusting the spanner nut and compressing the coilover spring. Allow the chain lube to dry before adjusting the spanner nut.

59. Raise the vehicle up on jack stands and adjust the ride height by turning the coilover spanner nut with the suspension in full droop. **NOTE:** Whenever you are setting the vehicle's ride height, DSE recommends disconnecting the sway bar.

WARNING: DO NOT ADJUST THE COILOVER ADJUSTING NUT WITHOUT THE VEHICLE RAISED OFF THE GROUND IN ORDER TO REMOVE THE WEIGHT OFF THE COILOVER SHOCKS. FAILURE TO FOLLOW THIS PROCEDURE WILL RESULT IN DAMAGED THREADS ON THE SHOCK BODY THAT CANNOT BE WARRANTIED.

60. DSE does include a spanner tool to adjust the ride height, however if you have the single adjustable coilover shocks, DSE does offer an adjustment tool available as PN: 031061DS if needed (Figure 42).



Figure 42 – DSE Spanner & Adjustment Tool

61. Once the ride height has been adjusted properly, lock the spanner nut in place. If you have the non-adjustable shocks, tighten the set screw in the spanner nut to the shock body. If you have the single adjustable shocks, tighten the lock ring to the spanner nut so they lock together in place.

62. The DSE lower control arms include adjustable steer stops on the backside of the control arms that can be adjusted depending on your wheel size and backspace. If you have enough wheel/tire clearance at full steering lock, you can remove the 3/8" hex bolt and remove the washers as needed to increase your turning radius (Figure 43).



Figure 43 – Adjustable Steer Stop

63. Have a professional alignment completed following the specifications in the chart on page 3. Installation is now complete (Figure 44).



Figure 44 - Installation Complete

64. If the single adjustable coilover shocks were purchased as an upgrade, refer to the following information for adjustment procedures.

Detroit Speed Single Adjustable Shock Applications

To change from the recommended "Detroit Tuned" valving, adjustments can be made independently to the rebound setting. The rebound is controlled by the sweeper at the lower shock mount (Shock is mounted body side up). The sweepers rotate clockwise (+) to increase the damping and counterclockwise (-) to decrease the damping (Figure 45a).

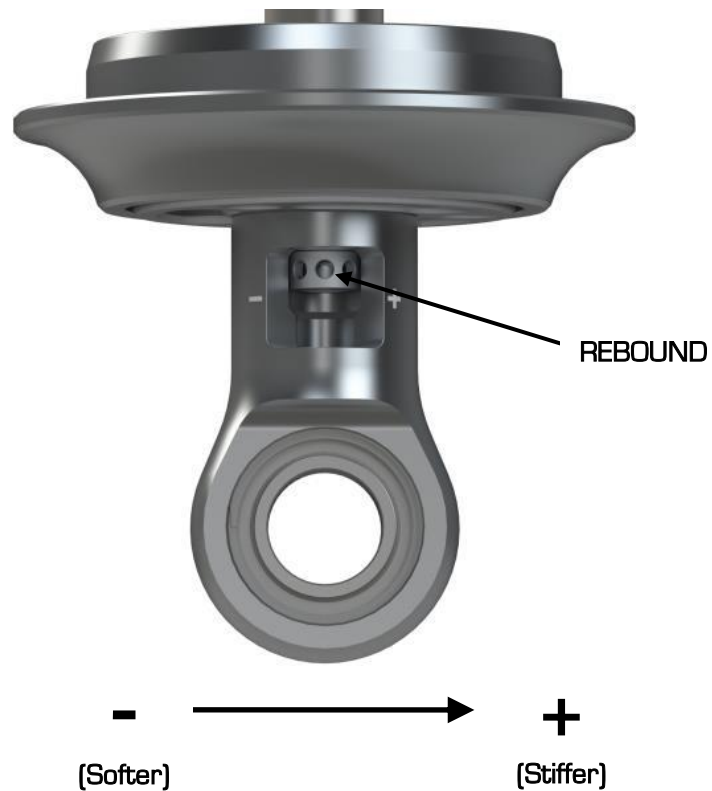

Figure 45a - Detroit Speed Single Adjustable Shock

To return to the DSE recommended settings, turn the sweeper clockwise (+) to full damping. Once at full damping, turn counterclockwise (-) to reach the recommended settings. Refer to Figure 45b for the rebound settings.

Rebound (Sweeper)..... 4 sweeps (counterclockwise) (-)
Figure 45b - DSE recommended settings.

Adjuster Operation



- **Tuning Notes**

- **Racetrack**

- For more grip, soften the damping.
 - For increased platform control, stiffen the damping.

- **Street**

- For a more comfortable ride, soften the damping.

***DO NOT FORCE KNOB WHEN IT STOPS TURNING, YOU MAY DAMAGE THE ADJUSTER AND INTERNAL HARDWARE**

If you have any questions before or during the installation of this product, please contact Detroit Speed at tech@detroitsspeed.com or 704.662.3272