



230-SWTS-X3

Can-Am Maverick X3
Turn Signal Kit with Horn
2019-21 Sport / 2017-21 X3

SSV WORKS, 201 N. Rice Ave Unit A, Oxnard, CA 93030

www.SSVworks.com | Phone: 818-991-1778 | Fax: 866-293-6751

WARRANTY INFORMATION:

ALL SWITCH Works Electronics are covered by a limited 1 year warranty against defects in material or workmanship. Contact SSV Works for further warranty information.



Please read and understand these instructions completely before installation to avoid possible injury, or damage to the accessory or vehicle.

FEATURES & BENEFITS:

- Left/Right Turn Signal with Automatic Canceling Feature
- Dedicated Horn Output
- License Plate Light Output
- Emergency Hazard Light Switch
- Direct plug in to the factory tail light connectors
- RGB Backlight Buttons
- Weather-Proof for Offroad Use
- Built-In Circuit Protection Detects Any Short Circuits, Over Current, Under Current and Low Voltage
- Programmable RGB Backlight Colors to Match the Dash Lights



BY



SWITCH Works Tango2 Parts List



Tango2 Turn Signal Module



Tango2 Turn Signal Rocker Switch



Tango2 Turn Signal Main Harness [B-H3271]



Can-Am X3 Rear Turn Signal Harness [B-H3205]



Tango2 Front Turn Signal LED Lamps (x2) [B-H2813]



Front Turn Signal Extension Harness (x2) [B-S2959]



Horn Assembly, 500hz [A-SW-HRN]



Zip Ties (x10)



Power Input Harness [B-H3413]



3-Pin Dummy Plug

SWITCH Works TANGO2 Maverick X3 Turn Signal Kit Wiring Diagram

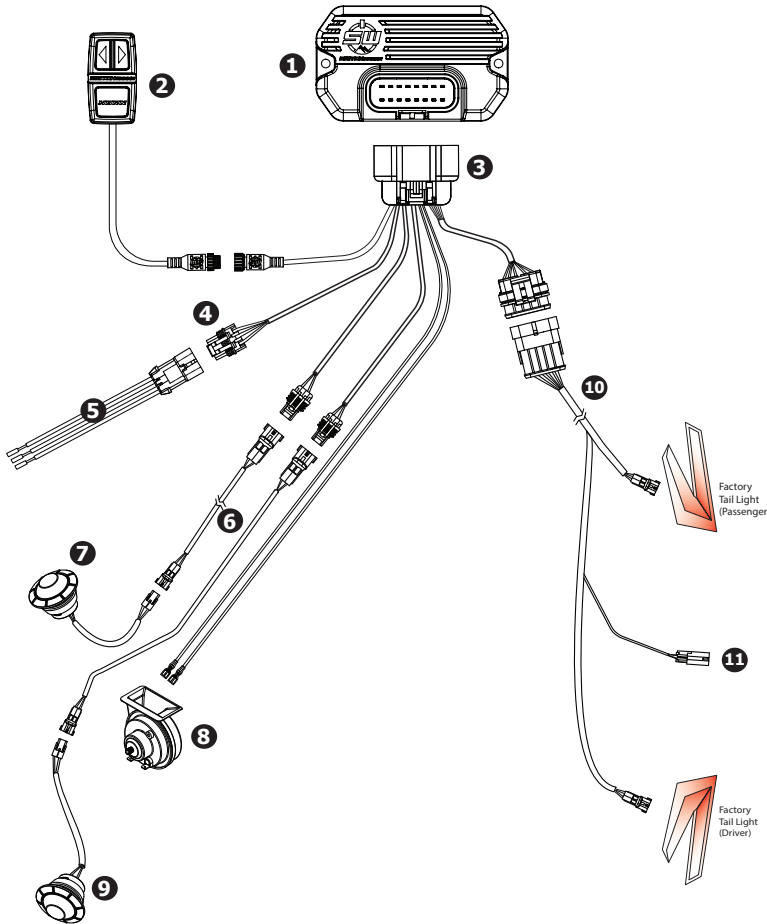

	Description	Part #
1	Tango2 Turn Signal Module	
2	Tango2 Turn Signal Rocker Switch	
3	Tango2 Turn Signal Main Harness	B-H2939
4	Power Connector to Busbar Pulse Connector	
5	Power Input Harness, 3 ft.	B-H3413
6	Front Turn Signal Extension Harness (x2)	B-H2959
7	LED Lamp (Front Right)	B-H2813
8	Tango2 Horn, 500 hz	B-SW-HRN-500
9	LED Lamp (Front Left)	B-H2813
10	Tango2 X3 Harness (to Rear)	B-H3205
11	To License Plate Light	

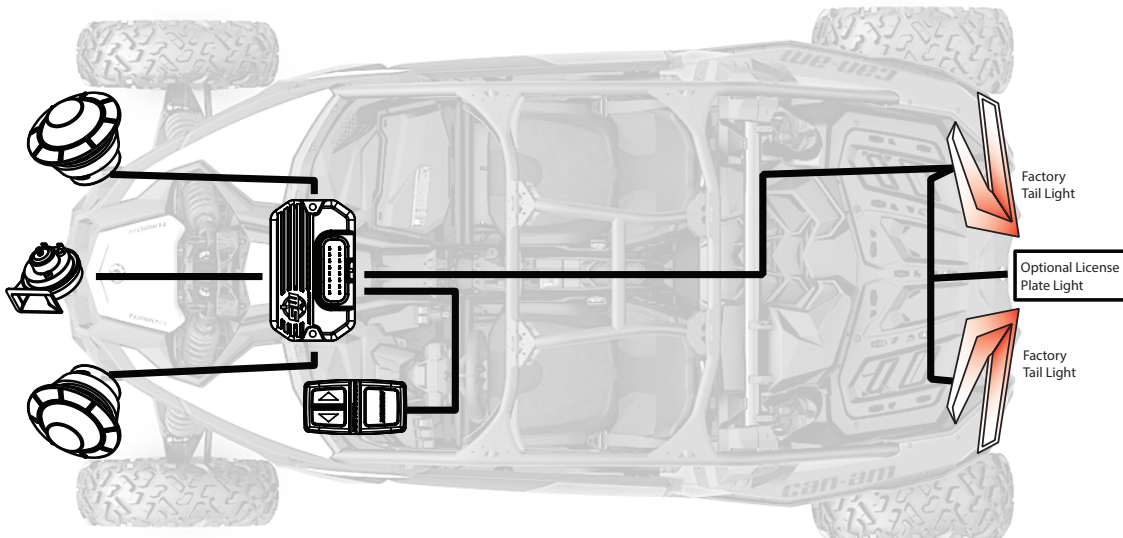

TOOLS NEEDED FOR INSTALLATION

- Phillips Screw Driver

- Drill

- 3/4" Hole Saw



A. Mount the module to the front section of the center console behind the start/stop switch.



B. Use a vacant rocker switch mounting slot and insert the TANGO2 turn signal rocker switch. Run the cable towards the TANGO2 brain module.

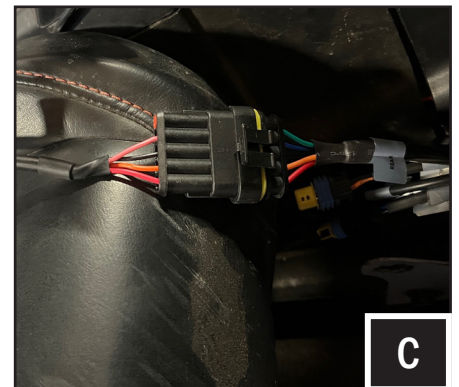
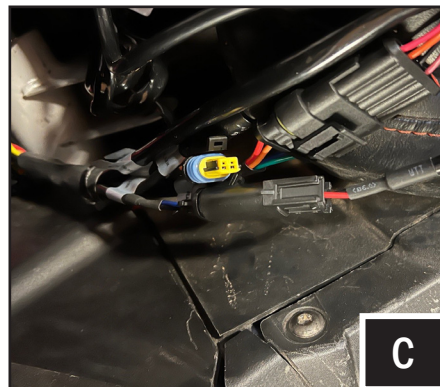
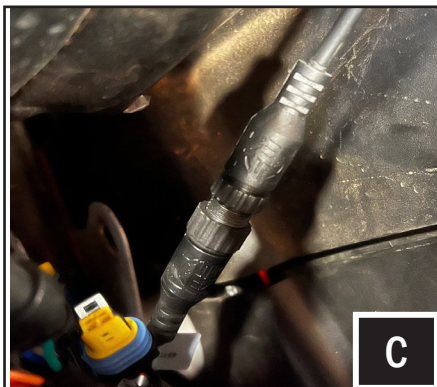

C. Plug in the controller cable, front turn signal extension cables (B-H2959) and rear turn signal harness (B-H3205) to the TANGO2 main harness (B-H3271).



D. Route the front left and right turn signal extension cables to the front of the vehicle. Make sure to route the correct cable connector end that will plug to the LED lamp. Run the Horn power wires to the desired horn location.

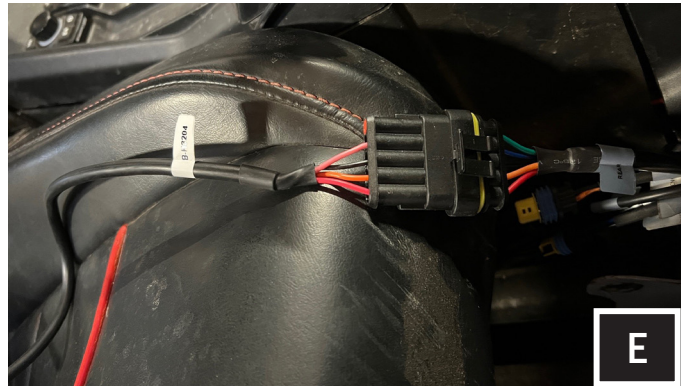

E. Run the TANG02 rear turn signal harness (B-H3205) to the rear of the vehicle. Use zip ties to secure the cable away from any moving parts or exhaust pipes.



F. Drill a 3/4" hole in the front of the vehicle for the front turn signal LED lamp. Refer to the viewing angle diagram on page 6 for proper turn signal LED lamp placement.



G. Insert the LED turn signal lamp into the hole and push in to lock in place. Repeat steps F and G for the other side.

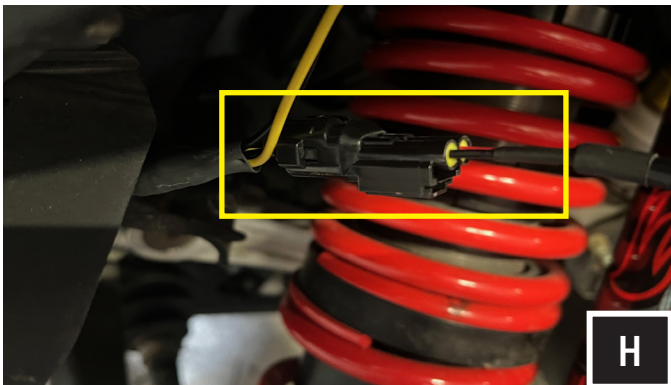

H. Connect the front turn signal extension harness to the LED lamp.

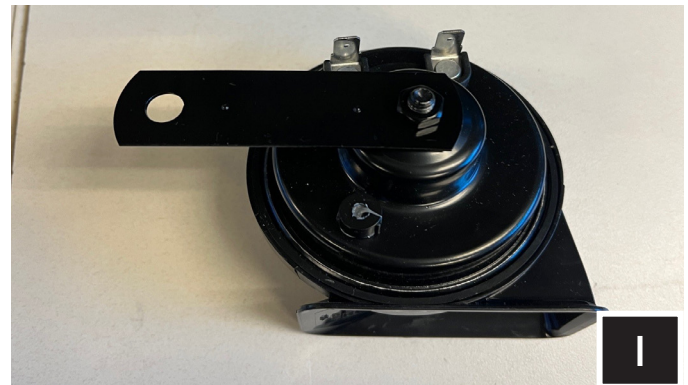

I. Mount the supplied bracket to the horn. Run the horn cable towards the desired horn mounting location.

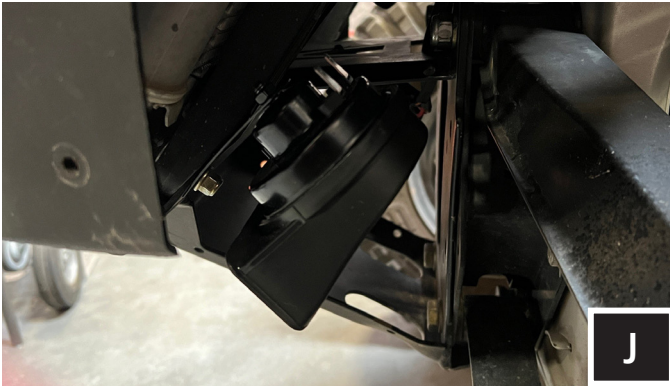

J. Horn mounting recommendations: 1. Mount away from moving parts; 2. Mount as high as possible; 3. Mount with the horn facing downward to protect from water damage.

Plug in the horn power wires. Either wire can connect to either terminal.



H. Unplug the factory tail light connector and plug it to the "PASS. INPUT" connector of the X3 Rear Turn Signal Harness (B-H3205).



I. Run the "LIC. PLATE" connector towards the license plate location. Use zip ties to secure the cable away from any moving parts or the exhaust pipe.



J. Run the "DRIVER OUTPUT" cable to the driver side tail light. Unplug the factory tail light connector and plug in the "DRIVER OUTPUT" connector of the X3 Rear Turn Signal Harness (B-H3205).



K. Plug in the provided dummy plug to the factory tail light connector to protect it from the elements.

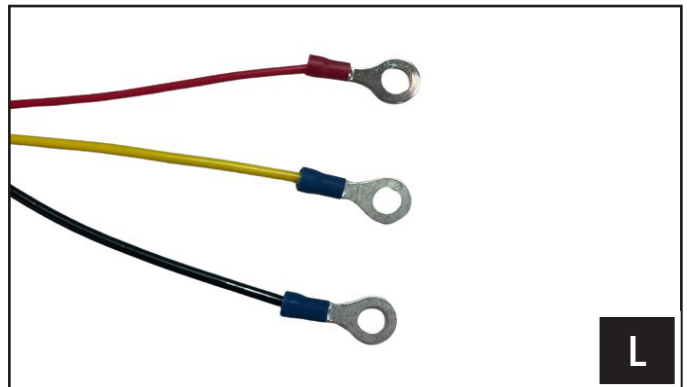

L. Crimp the ring terminals to the Power Input Harness (B-H3413).

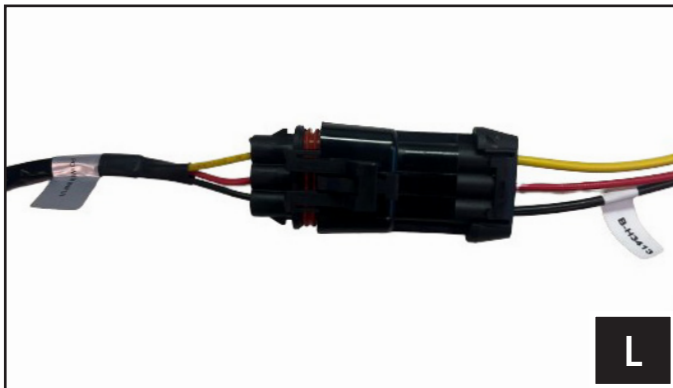

L. Plug the 3-pin connector of the Power Input Harness (B-H3413) to the X3 Turn Signal Main harness (B-H3271).

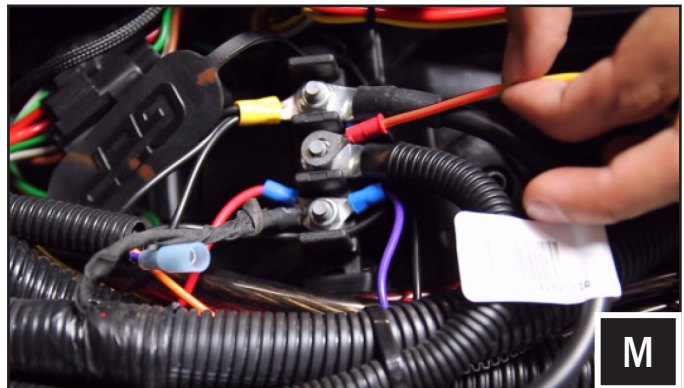

L. Run the BATT, GND and ACC wires of the Power Input Harness (B-H3413) to the factory busbar (passenger side center console) and screw in the ring terminals to the busbar.

Turn Signal 180° Degree Viewing Angle

Turn signal light should be viewable at a 180° angle from the front and rear of the vehicle.

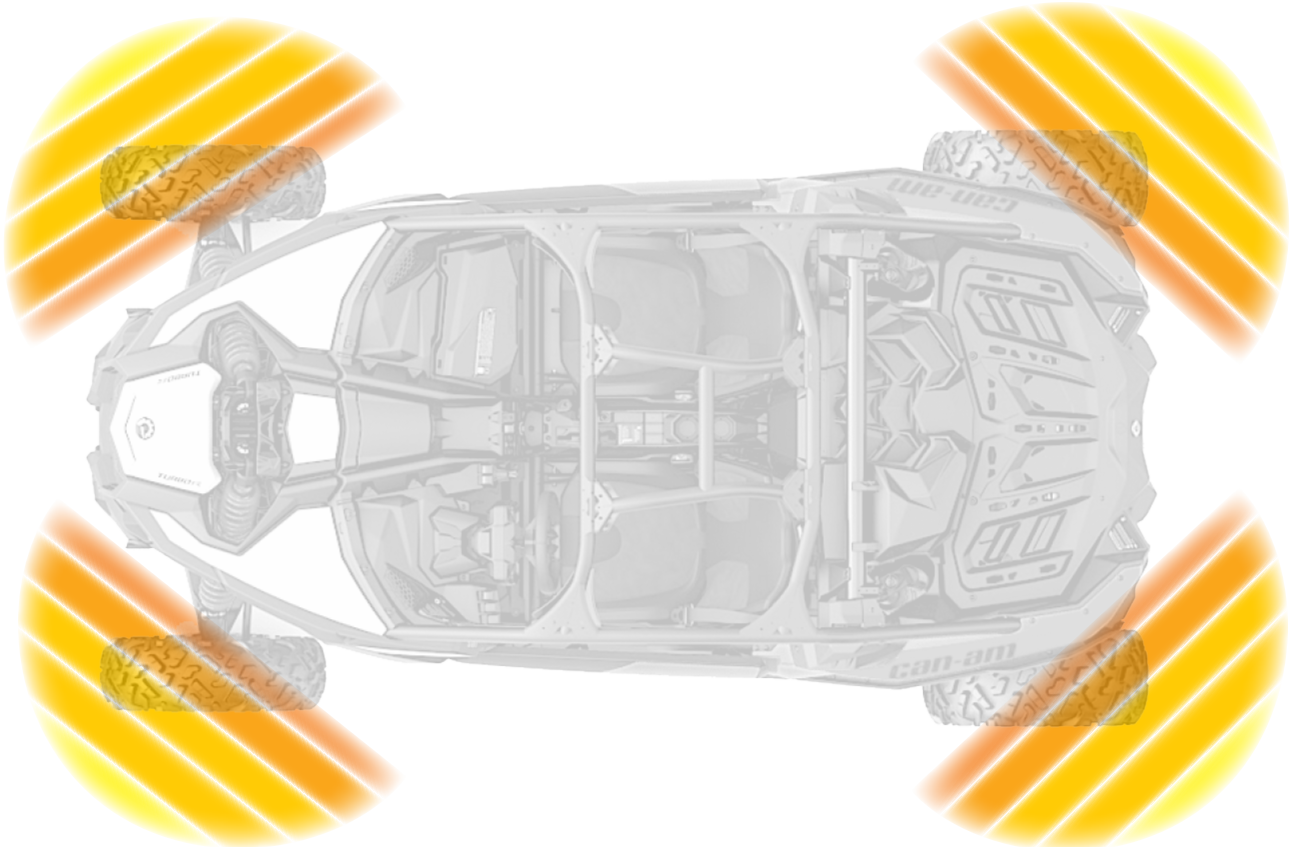

TURN SIGNAL ROCKER SWITCH FUNCTIONS

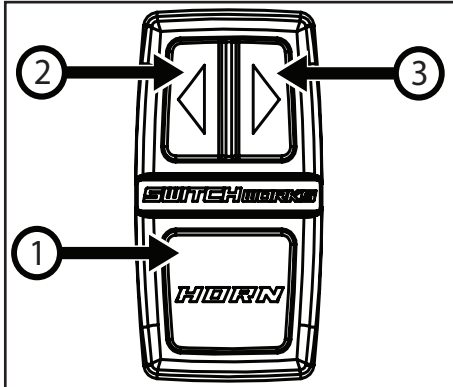

- ① Momentary Press = Horn Button
- ② Momentary Press = Left turn signal with 8-flash auto turn off
Press and Hold (1 sec) = Left turn signal continuous flashing / Press again to turn off
- ③ Momentary Press = Right turn signal with 8-flash auto turn off
Press and Hold (1 sec) = Right turn signal continuous flashing / Press again to turn off
- ② + ③ Press and Hold = Hazard lights (also works with ACC off)

LED BACK LIGHT COLOR CHANGE



With ACC off, press and hold either the left or right button for 4 seconds until the rocker switch backlight turns bright. Use the left and right buttons to select the color. Press the horn button to save the color.

SWITCH Works is a product by SSV Works. We are committed to your satisfaction and we know you will enjoy our products. If you have questions or need any assistance, please let us know.

[SSVWORKS.COM](https://www.ssvworks.com)
 1-818-991-1778 EXT 2
 SUPPORT@SSVWORKS.COM

Returns must be made within 30 days of purchase date. Claims for missing items or items damaged in transit must be received within five business days of receipt of merchandise. All returns must be in original packaging and in re-sellable condition. Shipping fees are not refundable.